

Tournoi Interne
Simple Messieurs 35
nc-40 (Tableau 1)



<u>CORDEBAR Sébastien</u>	40	②
		CORDEBAR S. 3/6 6/1 ab. Q1
<u>FORET Rémy</u>	NC	

<u>AMSELLI Lionel</u>	40	③
		GIRAUD C. wo Q2
<u>GIRAUD Christophe</u>	NC	

<u>DI PALMA Ugo</u>	NC	
		DI PALMA U. 6/1 6/0 Q3
<u>GARNIER Ronan</u>	NC	

<u>FREDY Lionel</u>	NC	
		FREDY L. 6/1 6/3 Q4
<u>BAUD Guillaume</u>	40	①

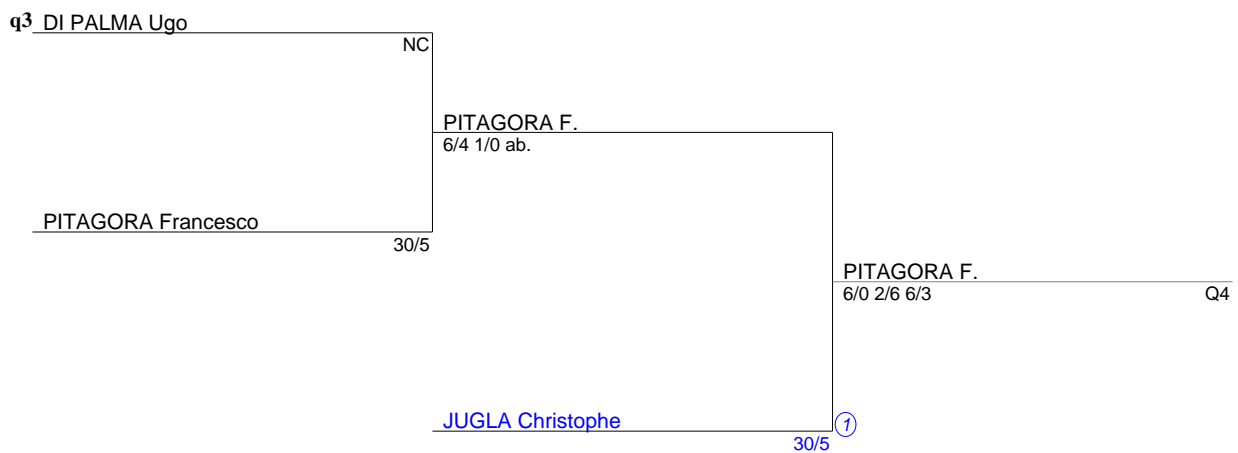
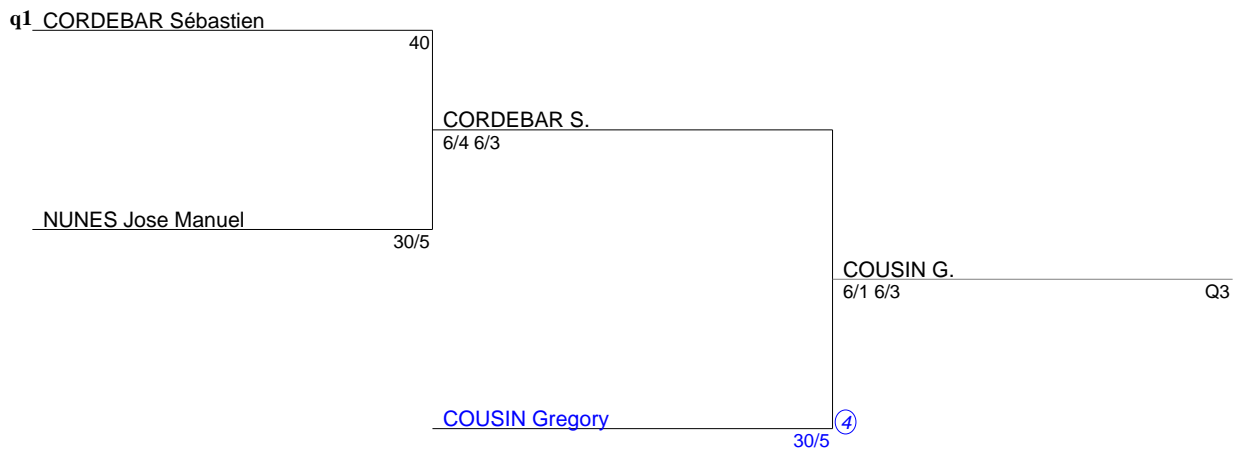
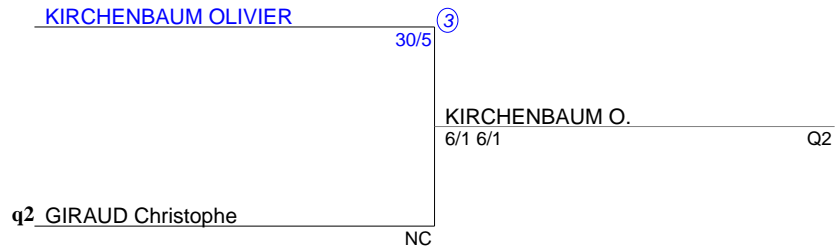
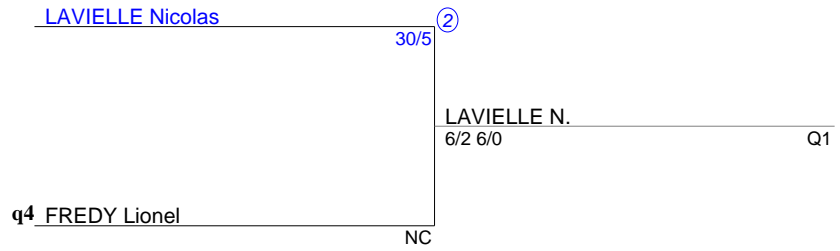

Tournoi Interne
Simple Messieurs 35
30/4 (Tableau 1)

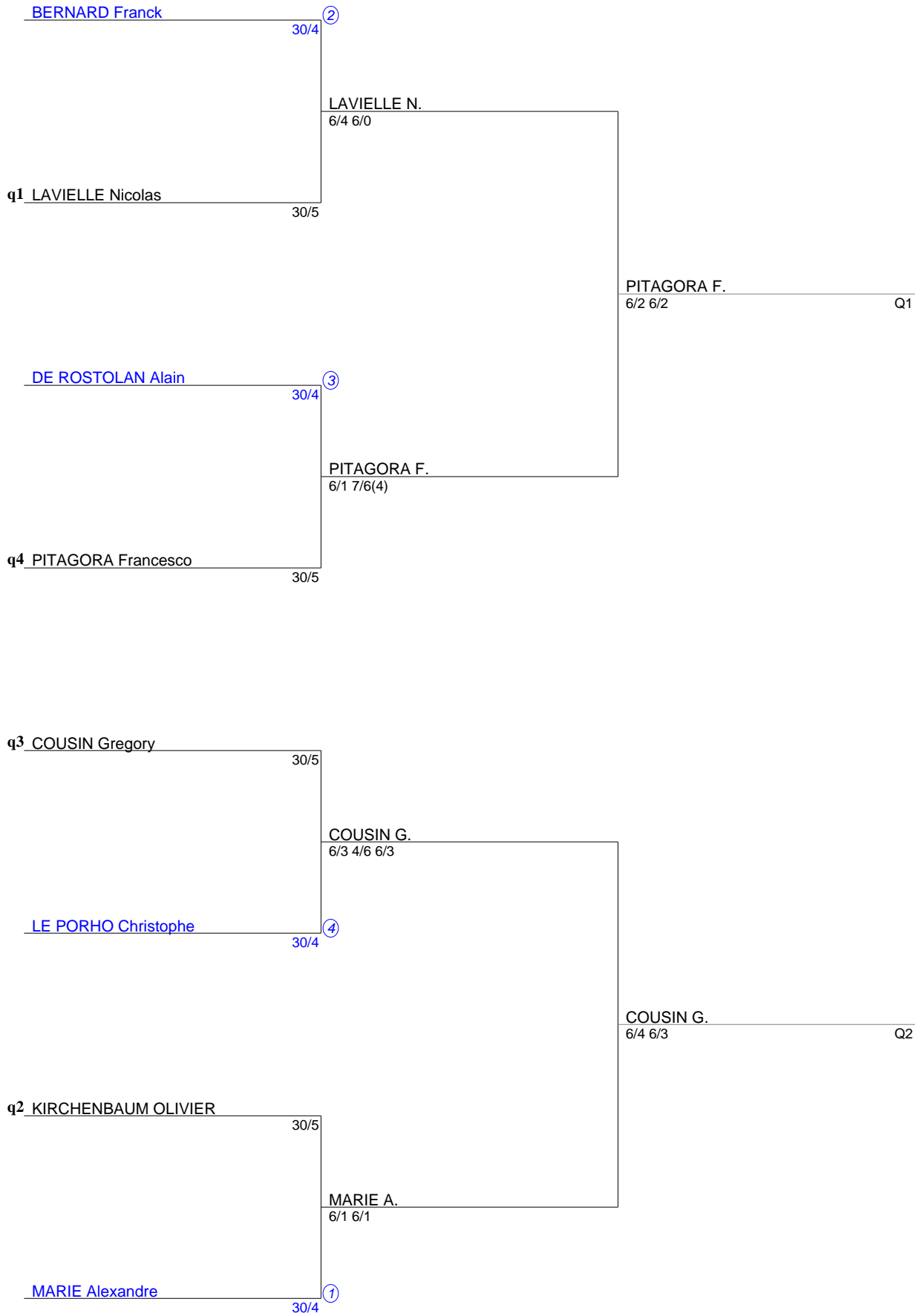

NGUYEN Huu Minh

30/2

②

NGUYEN H.

6/4 6/2

Q1

q2 COUSIN Gregory

30/5

q1 PITAGORA Francesco

30/5

YVON M.

6/4 7/6(5)

YVON Marc

30/3

DOYEN M.

6/3 2/6 6/3

Q2

DOYEN Michel

30/2

①

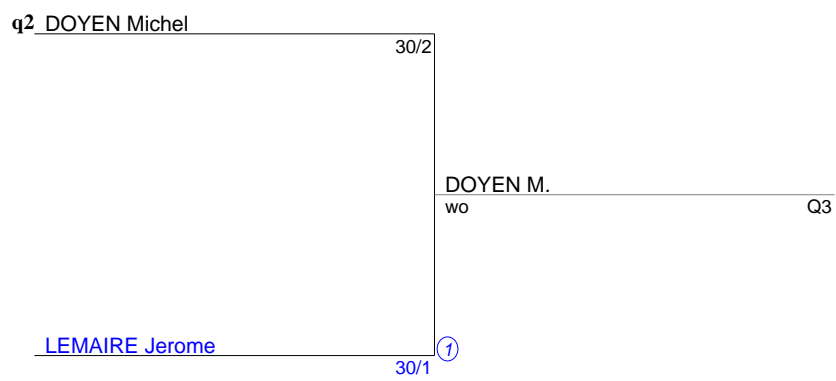
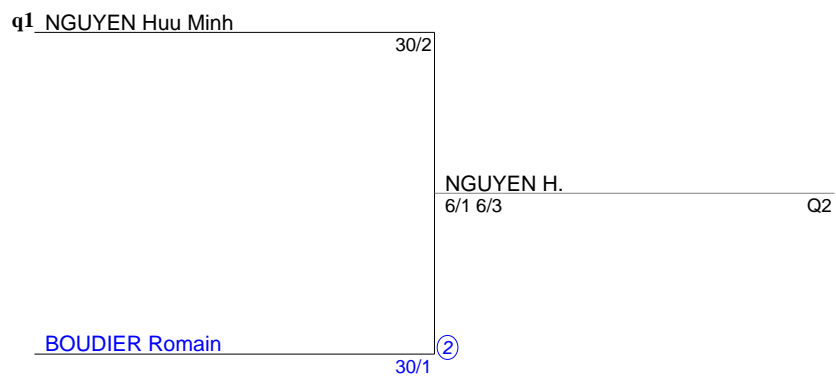
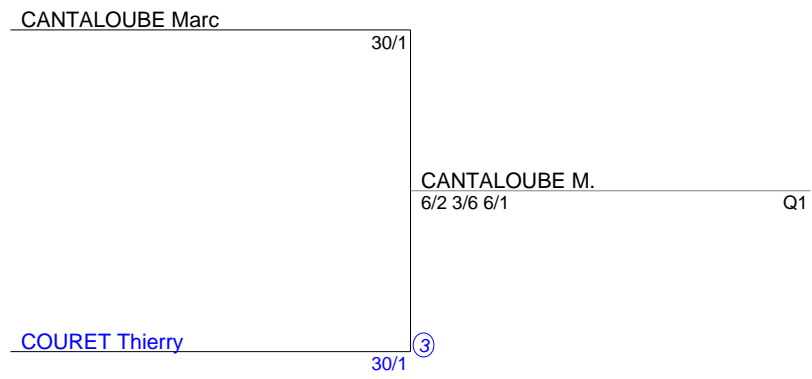

q2 _NGUYEN Huu Minh

30/2

MORISOT D.
6/3 7/6(5)

Q1

MORISOT David

30

③

q3 _DOYEN Michel

30/2

COURCIER C.
wo

Q2

COURCIER Christophe

30

②

SEJOURNE Christophe

30

CANTALOUBE M.
6/4 6/3

q1 _CANTALOUBE Marc

30/1

CANTALOUBE M.
7/6(5) 4/3 ab.

Q3

DUTHOIT OLIVIER

30

①

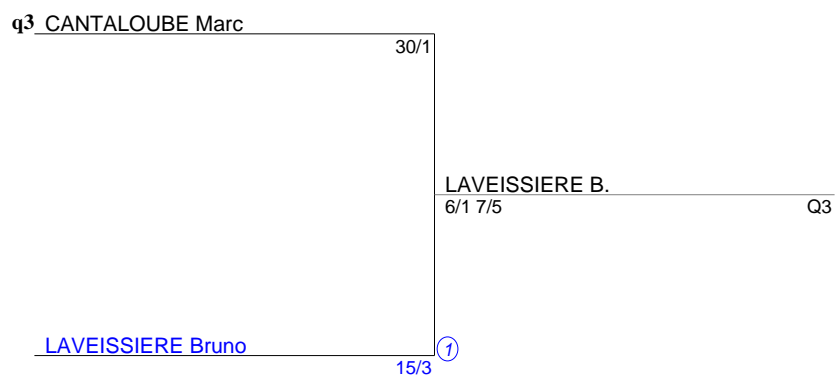
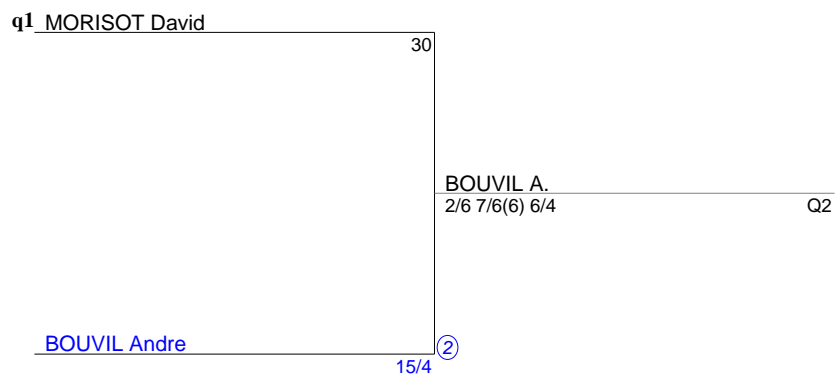
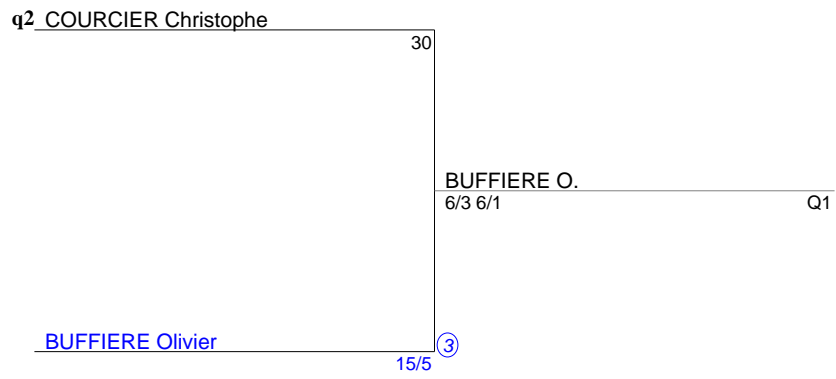

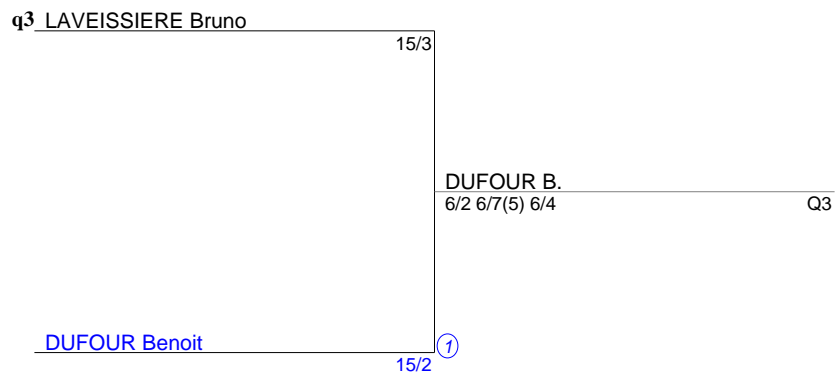
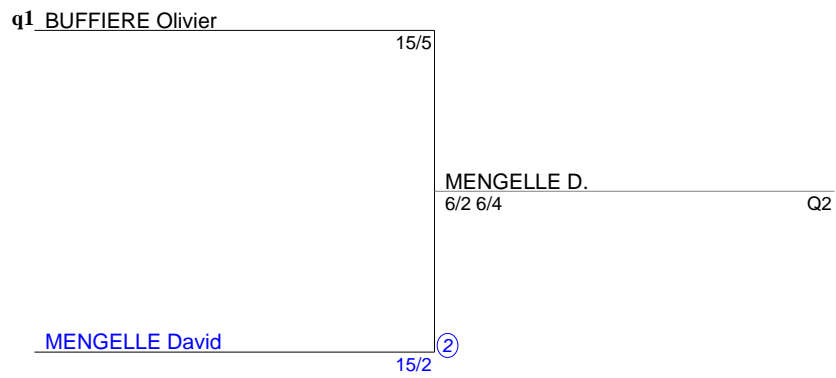
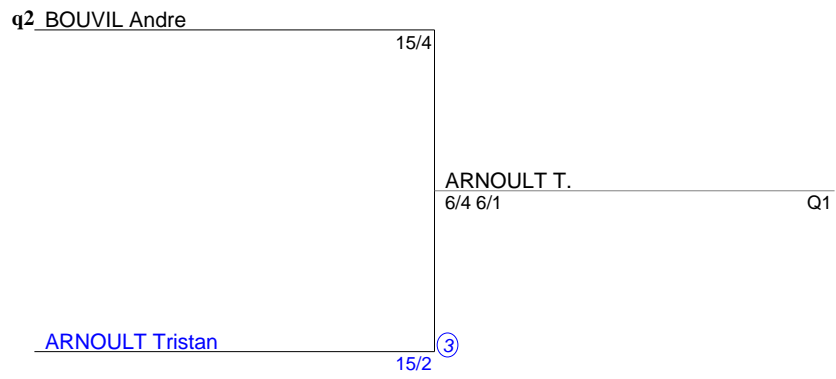

Tournoi Interne
Simple Messieurs 35
TF (Tableau 1)

